

# 'T' Table Legs

## 1200, 1500 & 1800 T-Legs Design

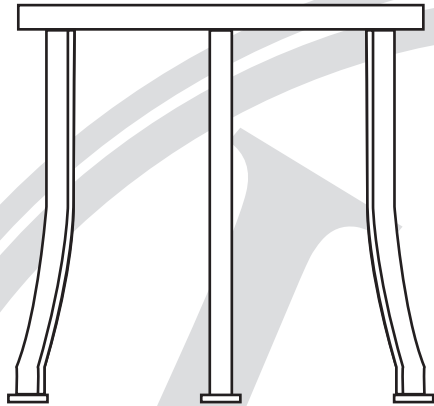

Round Legs Profile

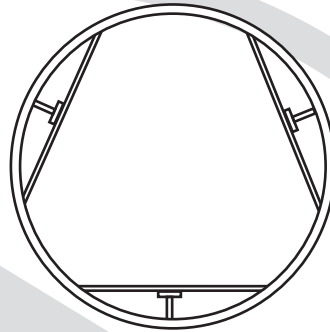

Round Legs Top View

## 1500 x 1000, 2000 x 1000, 2400 x 1200, 2700 x 1200 and 3000 x 1400 T-Legs Design



T-Legs Rectangle Profile

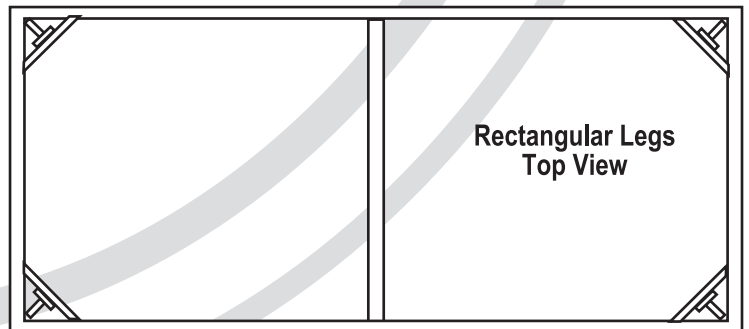

Rectangular Legs Top View

Top Size (mm)	Height	Width/Diameter	Recess Needed	Steel (mm)	Paint
1200 Round	720	900mm	910 mm	Galvinised 40 x10	Polyurathane
1500 Round	720	1260 mm	1280 mm	Galvinised 40 x10	Polyurathane
1800 Round	720	1575 mm	1585 mm	Galvinised 40 x10	Polyurathane
1500 x 1000 Rec	720	1290 x 790 mm	1305 x 805	Galvinised 40 x10	Polyurathane
2000 x 1000 Rec	720	1840 x 840 mm	1855 x 855	Galvinised 40 x10	Polyurathane
2400 x 1200 Rec	720	2190 x 990 mm	2205 x 1010	Galvinised 40 x10	Polyurathane
2700 x 1200 Rec	720	2470 x 990 mm	2480 x 1010	Galvinised 40 x10	Polyurathane
3000 x 1400 Rec	720	2700 x 1100 mm	None	Galvinised 40 x10	Polyurathane

# 'Old Style' Table Legs

## 600, 700 and 900 Legs Designs

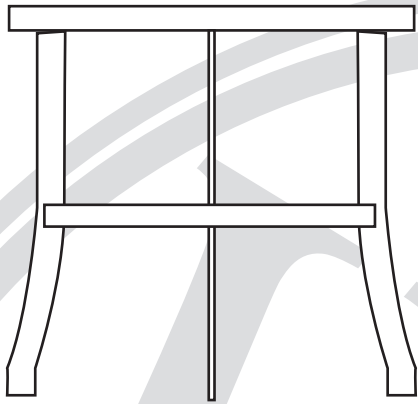

600, 700 and 900 Legs Profile

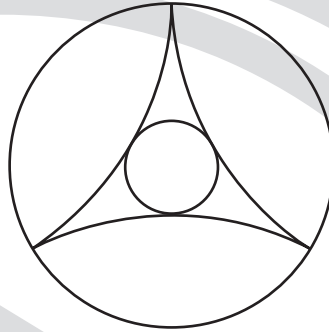

900 Legs  
Top View



600 and 700  
Legs  
Top View

## 1200 x 800 Coffee Table Legs Designs Options 1 And 2

### Option 1



Top View

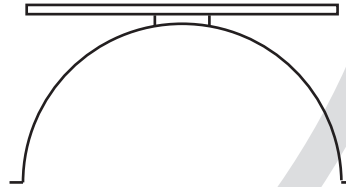

Front View

### Option 2

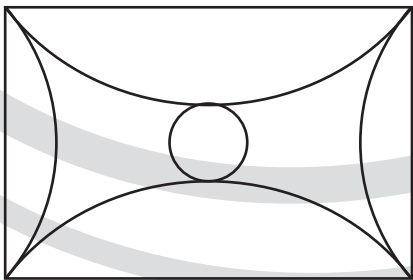

Top View



Side View

Top Size (mm)	Height	Width/Diameter	Recess Needed	Steel (mm)	Paint
600 Round	720	350 mm	365 mm	Galvinised 30x10	Polyurathane
700 Round	720	500 mm	510 mm	Galvinised 30x10	Polyurathane
900 Round	720	680 mm	700 mm	Galvinised 40x10	Polyurathane
800x1200 Rec	720	980 x 580 mm	995 x 590 mm	Galvinised 40x10	Polyurathane

# Table Tops – Rectangle

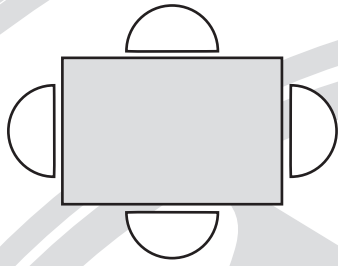

**1200x800 Rectangle**

<b>Seats</b>	4*
<b>Thickness</b>	±50mm
<b>Edge</b>	Moulded Sq. Bevel
<b>Recess</b>	1000x600mm
<b>Recess Depth</b>	16mm
<b>Approx. Weight</b>	72kg
<b>Finish</b>	Sealed, stain resistant

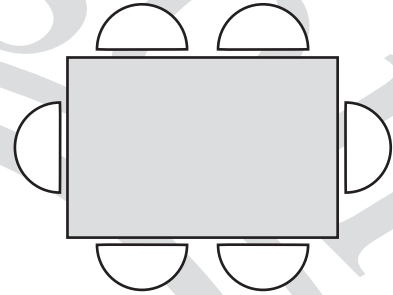

**1000x1500 Rectangle**

<b>Seats</b>	6*
<b>Thickness</b>	±50mm
<b>Edge</b>	Moulded Sq. Bevel
<b>Recess</b>	800x1300mm
<b>Recess Depth</b>	16mm
<b>Approx. Weight</b>	98kg
<b>Finish</b>	Sealed, stain resistant

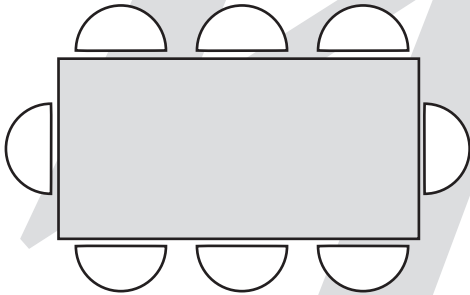

**2000x1000 Rectangle**

<b>Seats</b>	8*
<b>Thickness</b>	±50mm
<b>Edge</b>	Moulded Sq. Bevel
<b>Recess</b>	1860x860mm
<b>Recess Depth</b>	16mm
<b>Approx. Weight</b>	181kg
<b>Finish</b>	Sealed, stain resistant

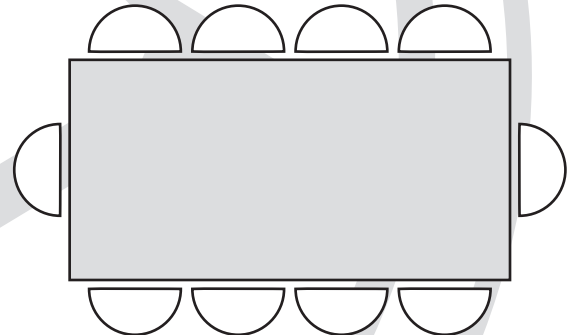

**2400x1200 Rectangle**

<b>Seats</b>	10*
<b>Thickness</b>	±70mm
<b>Edge</b>	Moulded Sq. Bevel
<b>Recess</b>	2220x1030mm
<b>Recess Depth</b>	32mm
<b>Approx. Weight</b>	312kg
<b>Finish</b>	Sealed, stain resistant

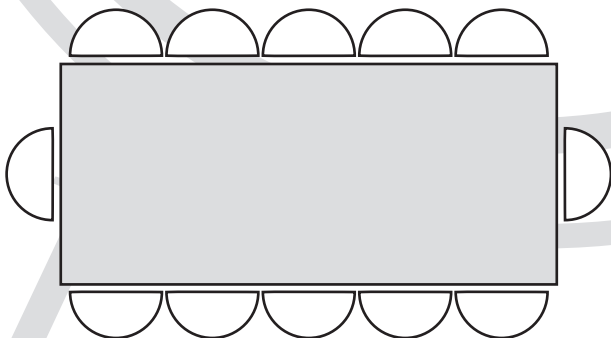

**2700x1200 Rectangle**

<b>Seats</b>	12*
<b>Thickness</b>	±70mm
<b>Edge</b>	Moulded Sq. Bevel
<b>Recess</b>	2220x1030mm
<b>Recess Depth</b>	32mm
<b>Approx. Weight</b>	373kg
<b>Finish</b>	Sealed, stain resistant

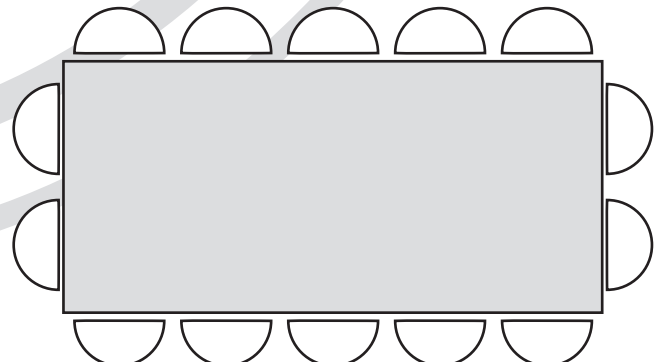

**3000x1400 Rectangle**

<b>Seats</b>	Max 14*
<b>Thickness</b>	±70mm
<b>Edge</b>	Moulded Sq. Bevel
<b>Recess</b>	2500x1020mm
<b>Recess Depth</b>	32mm
<b>Approx. Weight</b>	516kg
<b>Finish</b>	Sealed, stain resistant

\*Depending on width of chair

# WilsonStone



## Table Tops – Round

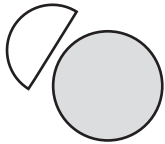

### 600 Round

<b>Seats</b>	1-2*
<b>Thickness</b>	±35mm
<b>Edge</b>	Moulded Sq. Bevel
<b>Recess Diameter</b>	510mm
<b>Recess Depth</b>	10mm
<b>Approx. Weight</b>	22kg
<b>Finish</b>	Sealed, stain resistant

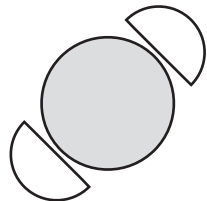

### 700 Round

<b>Seats</b>	2-3*
<b>Thickness</b>	±35mm
<b>Edge</b>	Moulded Sq. Bevel
<b>Recess Diameter</b>	510mm
<b>Recess Depth</b>	10mm
<b>Approx. Weight</b>	28kg
<b>Finish</b>	Sealed, stain resistant

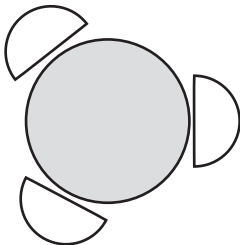

### 900 Round

<b>Seats</b>	2-3*
<b>Thickness</b>	±35mm
<b>Edge</b>	Moulded Sq. Bevel
<b>Recess Diameter</b>	710mm
<b>Recess Depth</b>	10mm
<b>Approx. Weight</b>	51kg
<b>Finish</b>	Sealed, stain resistant

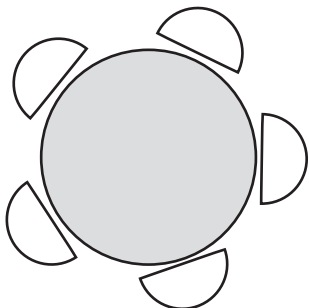

### 1200 Round

<b>Seats</b>	4-5*
<b>Thickness</b>	±35mm
<b>Edge</b>	Moulded Sq. Bevel
<b>Recess Diameter</b>	910mm
<b>Recess Depth</b>	10mm
<b>Approx. Weight</b>	72kg
<b>Finish</b>	Sealed, stain resistant

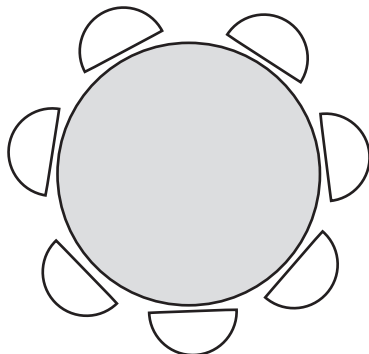

### 1500 Round

<b>Seats</b>	5-6*
<b>Thickness</b>	±50mm
<b>Edge</b>	Moulded Sq. Bevel
<b>Recess Diameter</b>	1300mm
<b>Recess Depth</b>	16mm
<b>Approx. Weight</b>	295kg
<b>Finish</b>	Sealed, stain resistant

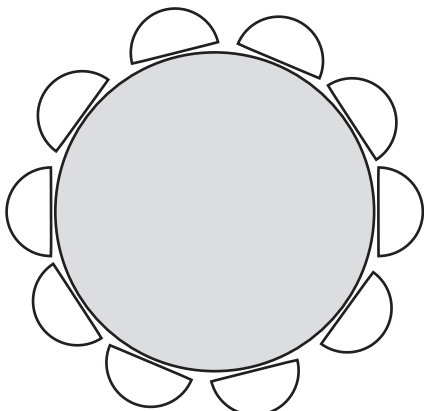

### 1800 Round

<b>Seats</b>	Max 10*
<b>Thickness</b>	±70mm
<b>Edge</b>	Moulded Sq. Bevel
<b>Recess Diameter</b>	1600mm
<b>Recess Depth</b>	16mm
<b>Approx. Weight</b>	365kg
<b>Finish</b>	Sealed, stain resistant



1000 x 1500 Rectangle Top & Galvanised Steel 'Twirl' Legs



1200 Round Top with Galvanised Steel Legs



900 Round Top with Galvanised Steel Legs & Foldable Daisy Chair



600 Round Top with Galvanised Steel Legs & Foldable Daisy Chair

\*Depending on width of chair