

WilsonStone

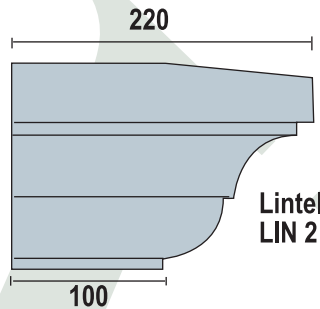

Window Cills/ Lintels/String Courses/Pediment

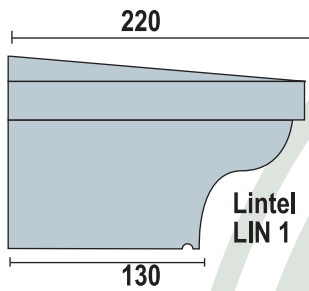
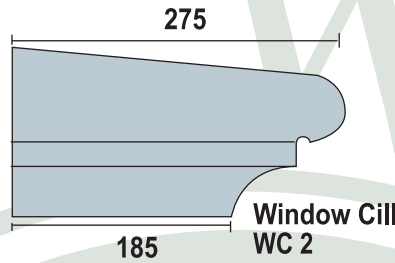
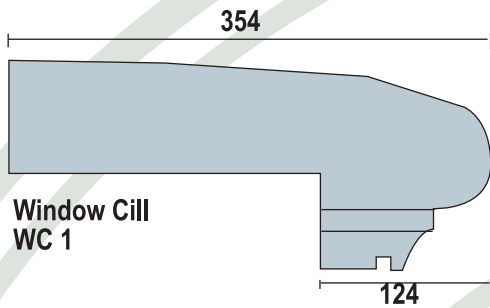

String Courses

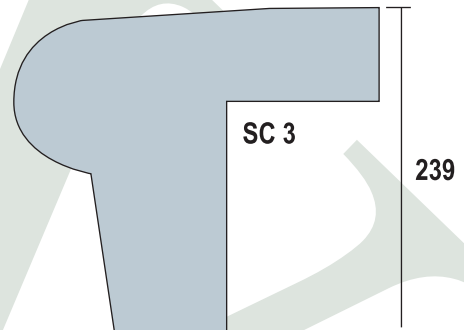
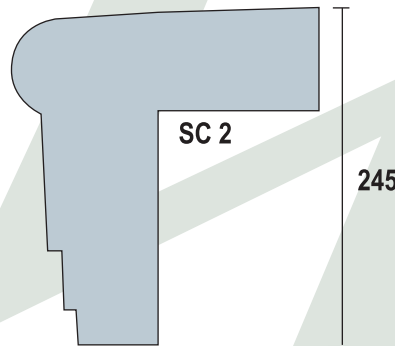
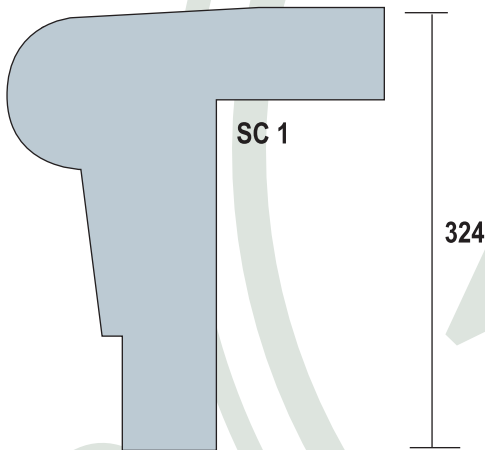

Internal Corners
External Corners
LH & RH Returns
available

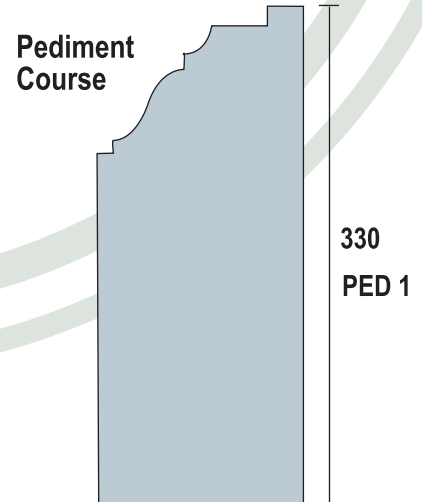
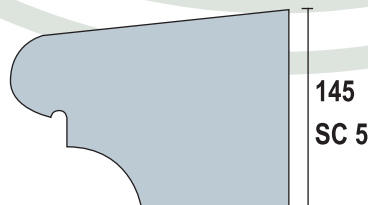
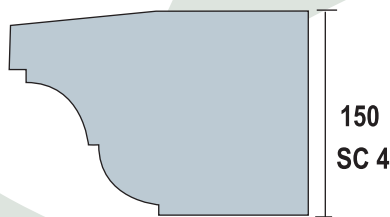

WilsonStone



Corbels/Pier Caps

Corbels

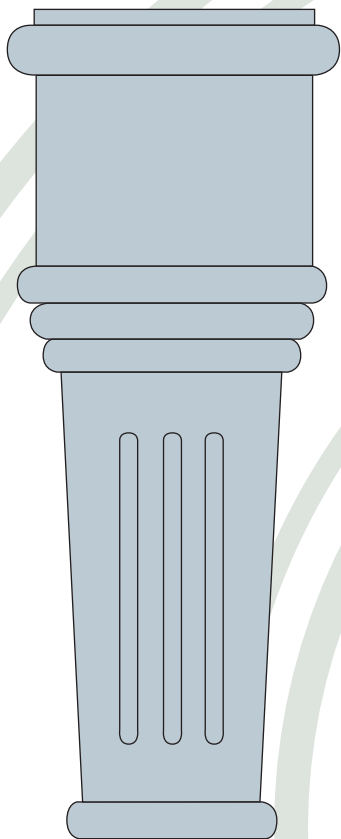

COR 1

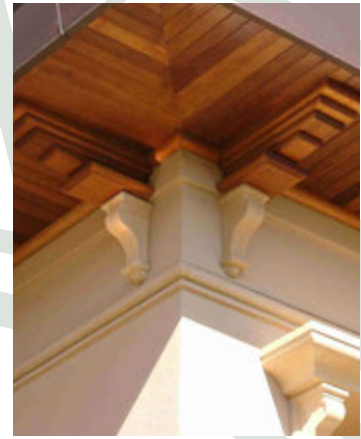
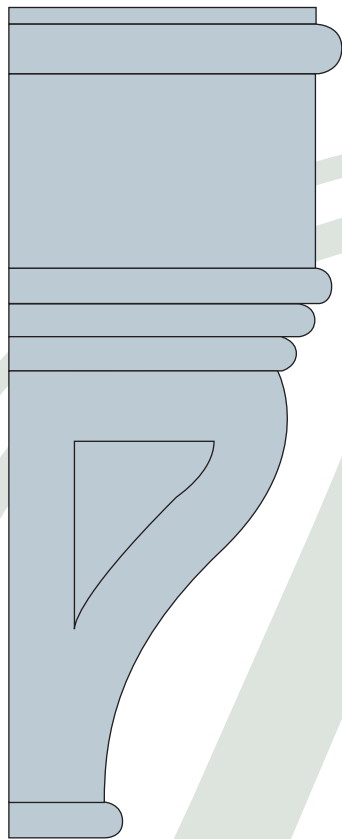

970

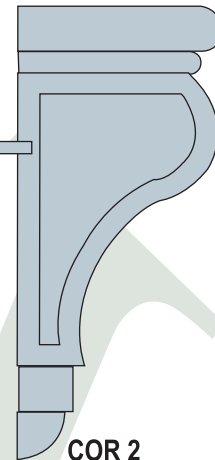

COR 2

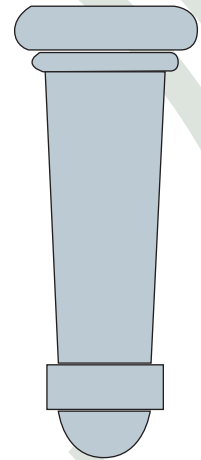

300

Pier Caps

Bell Pier Cap
PC 1

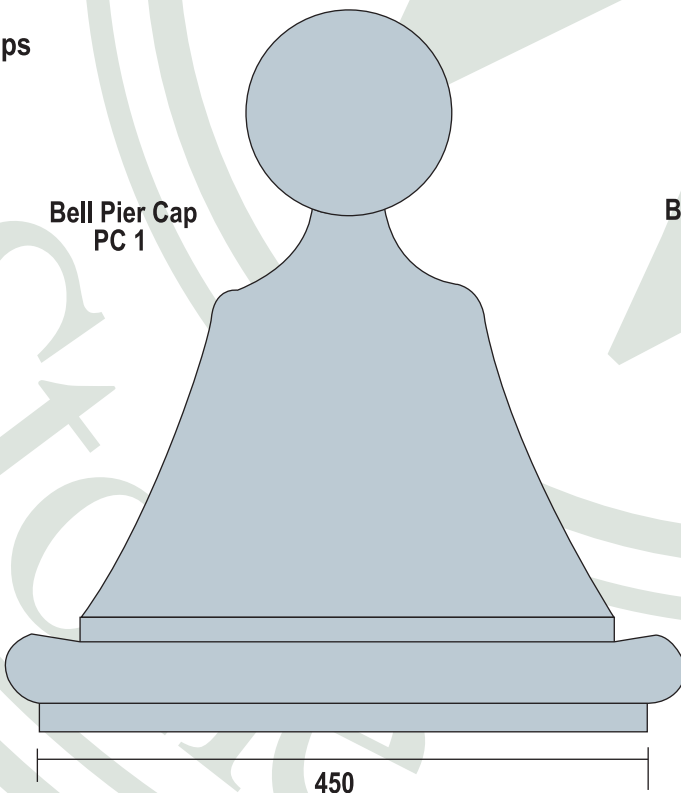

450

Ball Pier Cap
PC 2

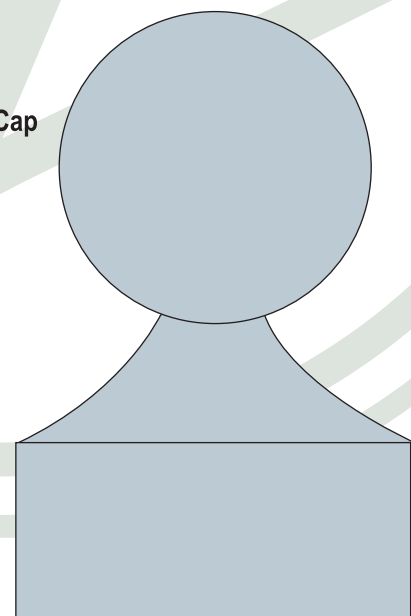

260

WilsonStone



Balustrading

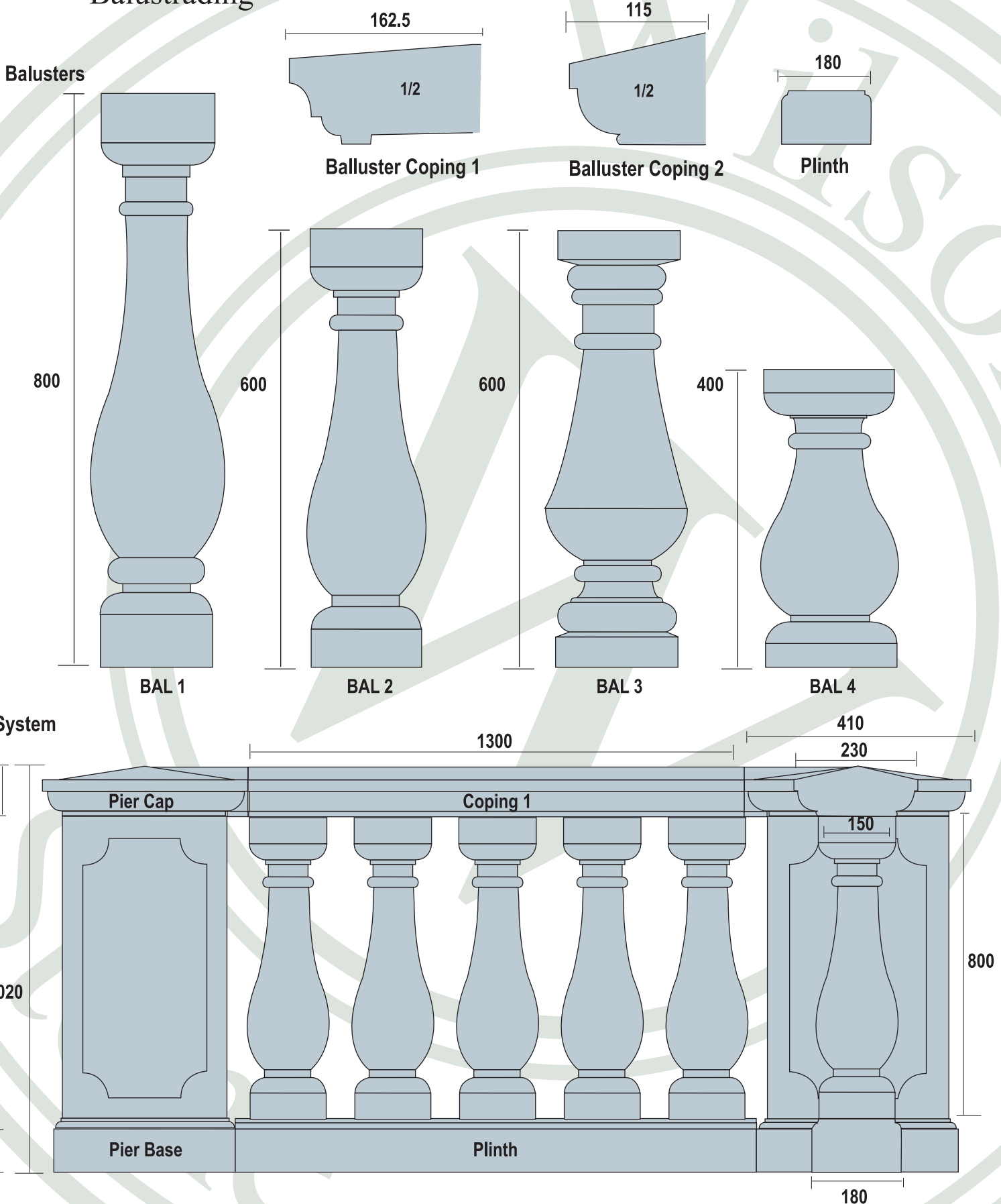

Showroom: 157 Queen St, Kensington. P.O. Box 28540, Kensington, 2101.

Tel: Showroom (011) 616 7129, Factory (011) 901 1208, Fax (011) 616 6531. Mail: wilsons2@mweb.co.za. www.wilsonstone.co.za

WilsonStone



Pillar Caps

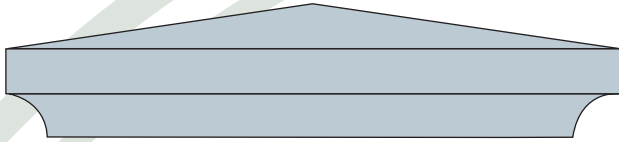

PC 3
Base size square: 600

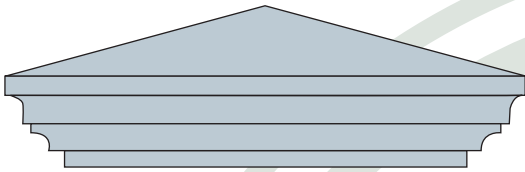

PC 4
Base Size Square: 360, 475

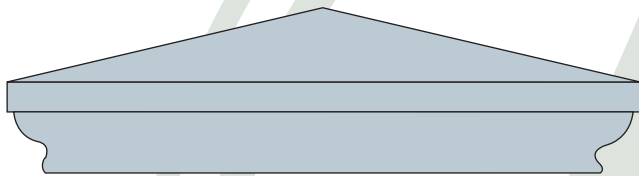

PC 5
Base Size Square: 480, 810

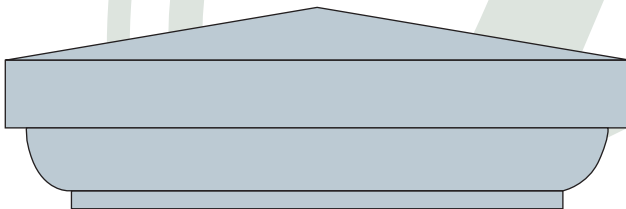

PC 9
Base Size Square: 650

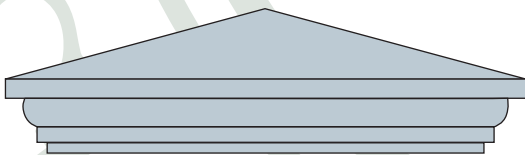

PC 11
Base Size Rec: 1175 x 475

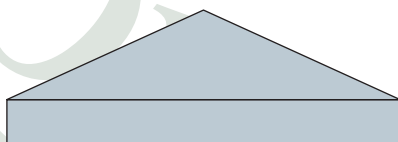

PC 13
Base Size Square: 520

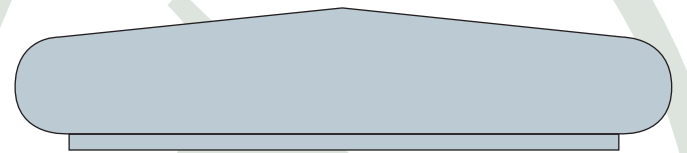

PC 8
Base Size Square: 650

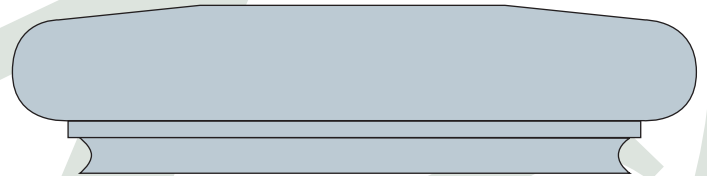

PC 10
Base Size Square: 715

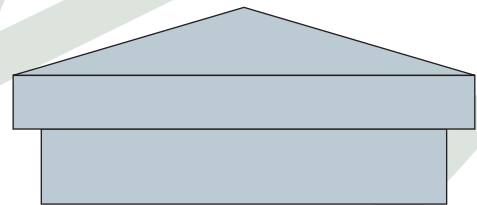

PC 12
Base Size Rec: 980 x 680, 980 x 525

WilsonStone



Wall Coping

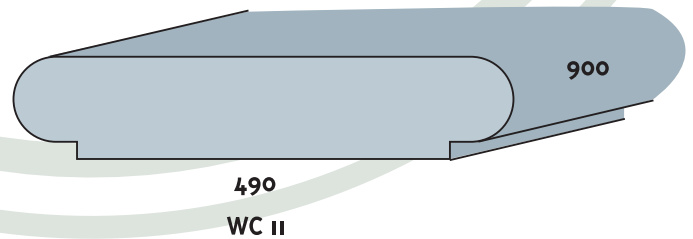
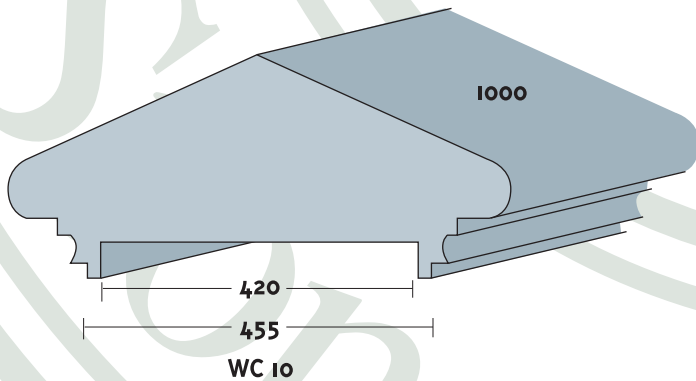
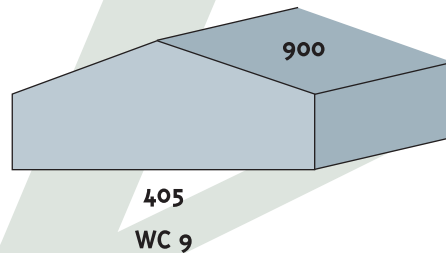
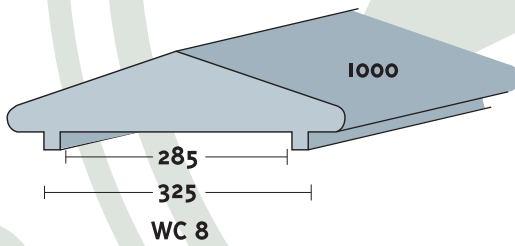
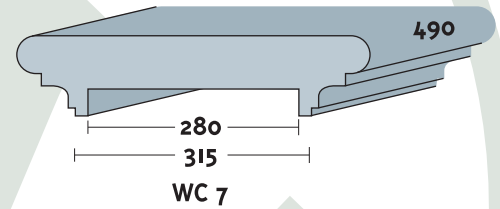
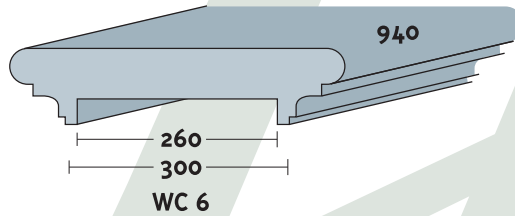
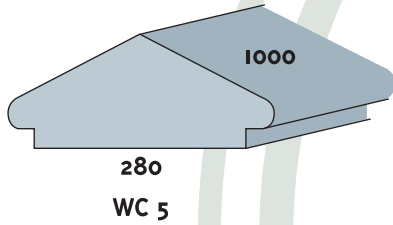
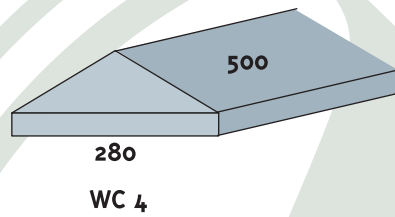
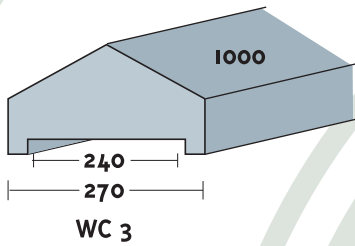
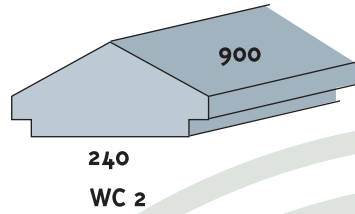
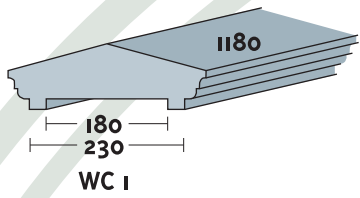

Showroom: 157 Queen St, Kensington. P.O. Box 28540, Kensington, 2101.

Tel: Showroom (011) 616 7129, Factory (011) 901 1208, Fax (011) 616 6531. Mail: wilsonsz@mweb.co.za. www.wilsonstone.co.za

WilsonStone



Window Frames

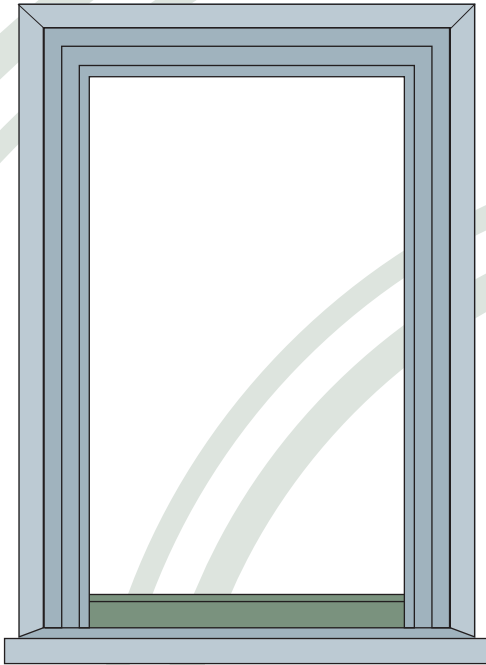

Sizes Available to Fit a Window (mm):

1500 x 1200
1200 x 1200
1200 x 900
900 x 900
900 x 600